

BROWN & ZORTMAN MACHINERY CO.
4 West Manilla Avenue
Pittsburgh, Pa. 15220



Catalog No. R-40

BICKFORD 13''-19'' CHIPMASTER[®] RADIAL DRILLING MACHINES

... the heavy-duty
machines for drilling,
boring, reaming,
tapping, and related
operations



GIDDINGS & LEWIS MACHINE TOOL COMPANY
FOND DU LAC, WISCONSIN • ESTABLISHED 1859

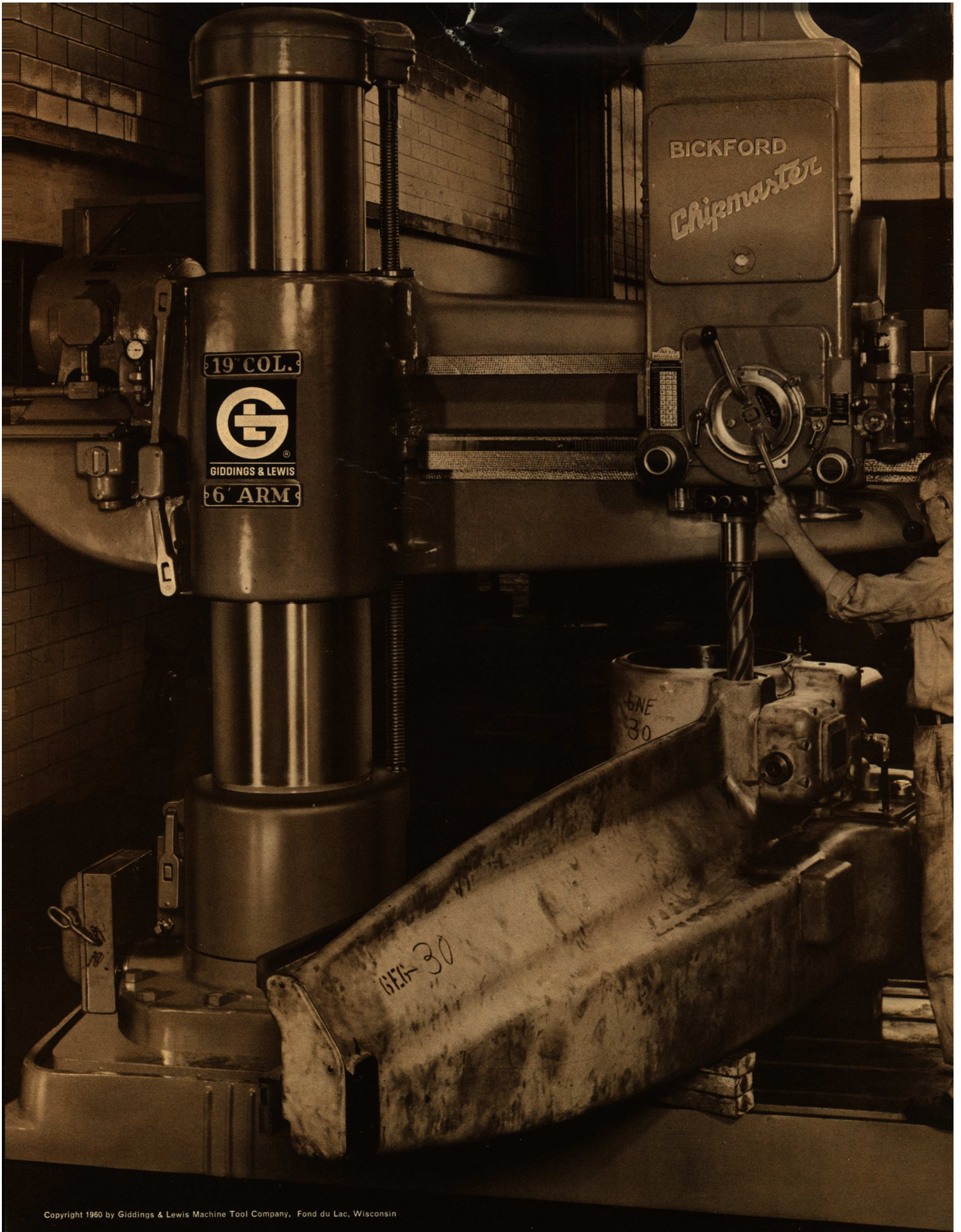

BICKFORD 13"-19" CHIPMASTER RADIALS

... give you more for your
drilling machine dollar!



Actual size chip made at .100" feed/rev with a 3" twist drill driven in solid steel at 45 rpm by a 25-hp, 6'-19" Chipmaster radial drilling machine.

Here's the heaviest chip ever made on a radial drill—produced at .100" feed per revolution

Drilling this big chip illustrates the tremendous thrust generated by the Chipmaster radial that did the job. The power, thrust, and rigidity that enable the Chipmaster to produce the big chip will pay big dividends in any shop.

Smooth delivery of power through the Chipmaster's exclusive *herringbone* gear drive, and massive, four-bearing spindle enables the operator to apply full machine horsepower at the tool, under heavy feeds and slow speeds.

The Chipmaster column, preloaded on dual taper roller bearings, is up to 17 $\frac{7}{8}$ " shorter than other radials—without sacrificing work height. Rugged, close-coupled construction, effecting one-piece column construction, provides maximum rigidity to resist deflection, lets you apply heavier feeds for more production per hour.

The Chipmaster spindle rides in precision, preloaded bearings. It *never* feeds away from its support—spindle, bearings, and sleeve feed down together for maximum rigidity.

Chipmaster radials are built in 13", 15", 17", and 19" column diameters with 4, 5, 6, 7, and 8-ft. arms. Drive motors range from 10 to 30 hp. Three optional head designs are available: mechanical shift, partial preselect (of speeds only), or full preselect (of both speeds and feeds).

Optimum production is assured on these machines by 36 speeds (to 2300 rpm) in any of five ranges, 18 feeds from .004" to .125", and a choice of three ranges of positive geared tap leads.

Before you buy your next radial, watch a Chipmaster work.

The machines and products illustrated and described in this catalog are fully protected by United States and foreign patents, patents pending and applied for. The illustrations and specifications published in this catalog are not binding in detail as we reserve the right to make changes and improvements and to incorporate them in the machines as conditions warrant.

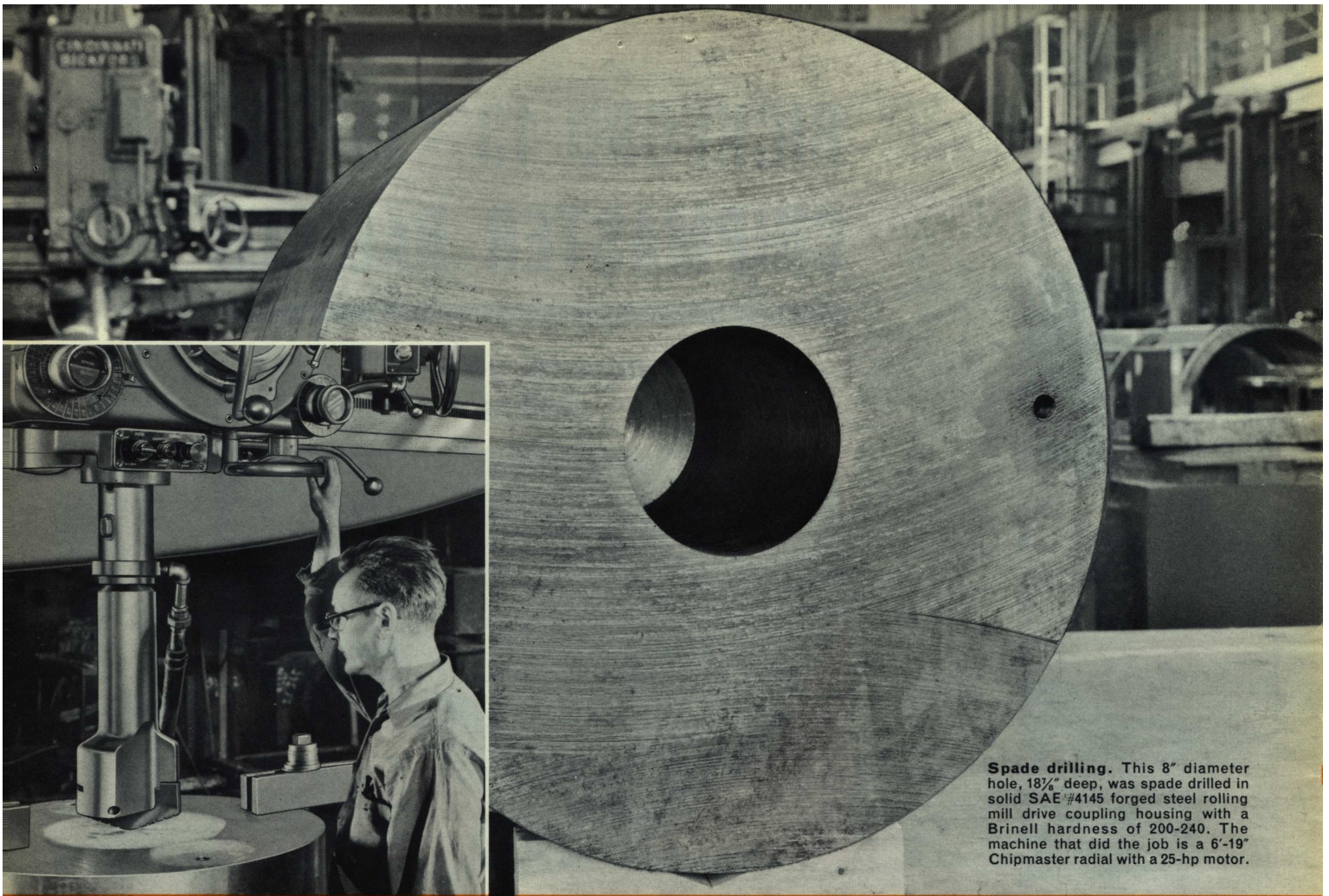

Spade drilling. This 8" diameter hole, 18 $\frac{1}{2}$ " deep, was spade drilled in solid SAE #4145 forged steel rolling mill drive coupling housing with a Brinell hardness of 200-240. The machine that did the job is a 6'-19" Chipmaster radial with a 25-hp motor.

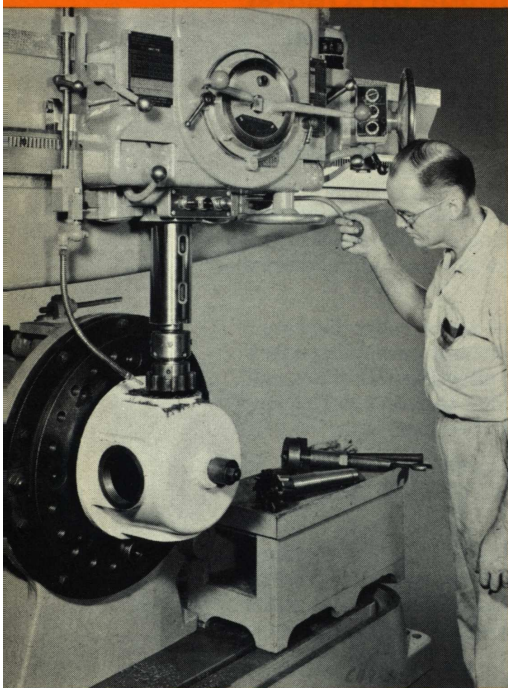

Boring "banjo" housing. Here is a job that proves a radial-boring 19 $\frac{1}{2}$ " diameter in cast steel differential housings on a production-line basis. Chipmaster radials also are used for drilling, tapping, and facing these parts.

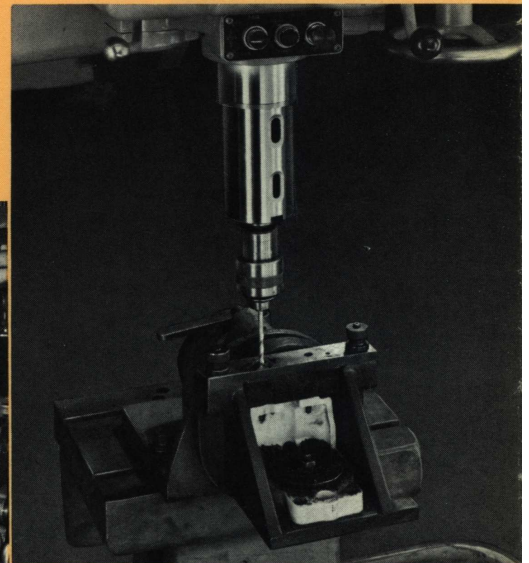

Small-hole drilling and tapping. The same Chipmaster that handles heavier jobs than any other radial is an accurate, sensitive machine that handles $\frac{3}{16}$ " and $\frac{1}{4}$ " drills and taps at high speeds.

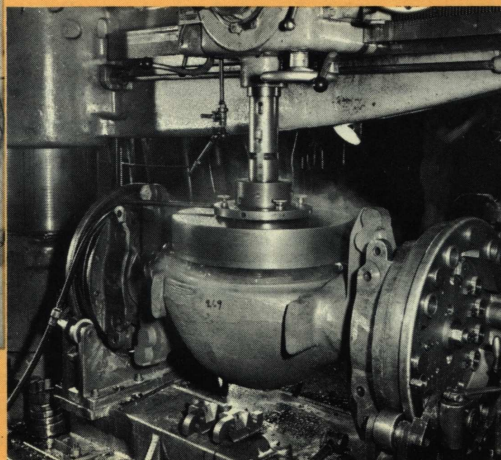

Tapping Class 3 threads. Accurate tap leads and complete freedom from backlash enable the Chipmaster to tap 5" bores in this explosionproof motor housing with a *guaranteed* Class 3 thread. Versatility built into this machine permits positive control whether tapping $\frac{1}{8}$ " or 10" pipe taps.

VERSATILE CHIPMASTER RADIALS CAN DO MORE JOBS FOR YOU

Bickford Chipmasters provide a wider range of opportunities for greater profits and increased production than any other radial drilling machines.

Rigid, close-coupled construction, extra thrust capacity, and precise control enable you to handle any job—from light drilling

and tapping to the heaviest boring, facing, spade drilling, and trepanning operations.

With the Chipmaster you can do work now being done on slower, more costly machines.

You can use optimum feeds and speeds for more work per hour. You can take full advantage of carbide tooling.

Jobs like those pictured prove no other drilling machine is so versatile—so productive. Note position of the arm on column which provides a clear view of work with tool fully exposed to the operator.



GIDDINGS & LEWIS

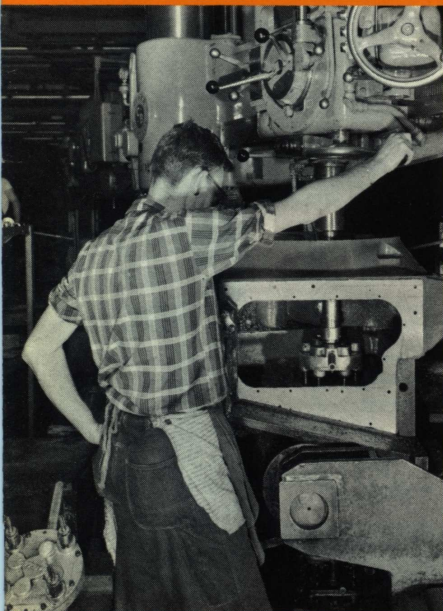

Multiple drill head, mounted on the spindle of a standard Chipmaster radial, drills six $27/64$ " holes in a steel transmission case. Feed is $.006$ "/rev at 732 rpm. A second special multiple-spindle head, which can be seen on the workbench behind the operator, is used to tap four $1/2$ " 13 thd holes. Changing of multiple-spindle heads takes less than one minute.

Drilling $1\frac{3}{4}$ " hole in a welded all-steel frame for three-ton electric hoist. Feed is $.025$ "/rev at 175 rpm.

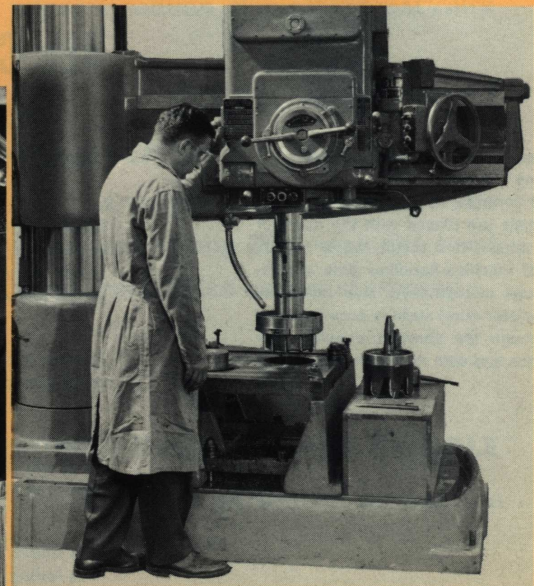
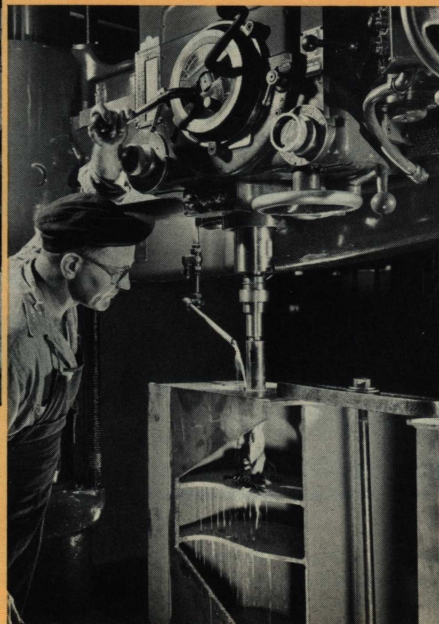

Trepanning from solid, boring and tapping semisteel for an 8" pipe tap using 13" column Chipmaster. Feed of $.050$ "/rev at 45 rpm is used for boring and trepanning. Pipe tapping is done at 22 rpm.

A CHOICE OF

- Start-stop-reverse lever actuates gearshifting

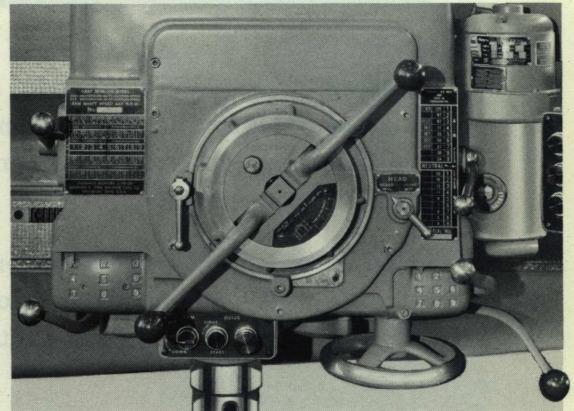
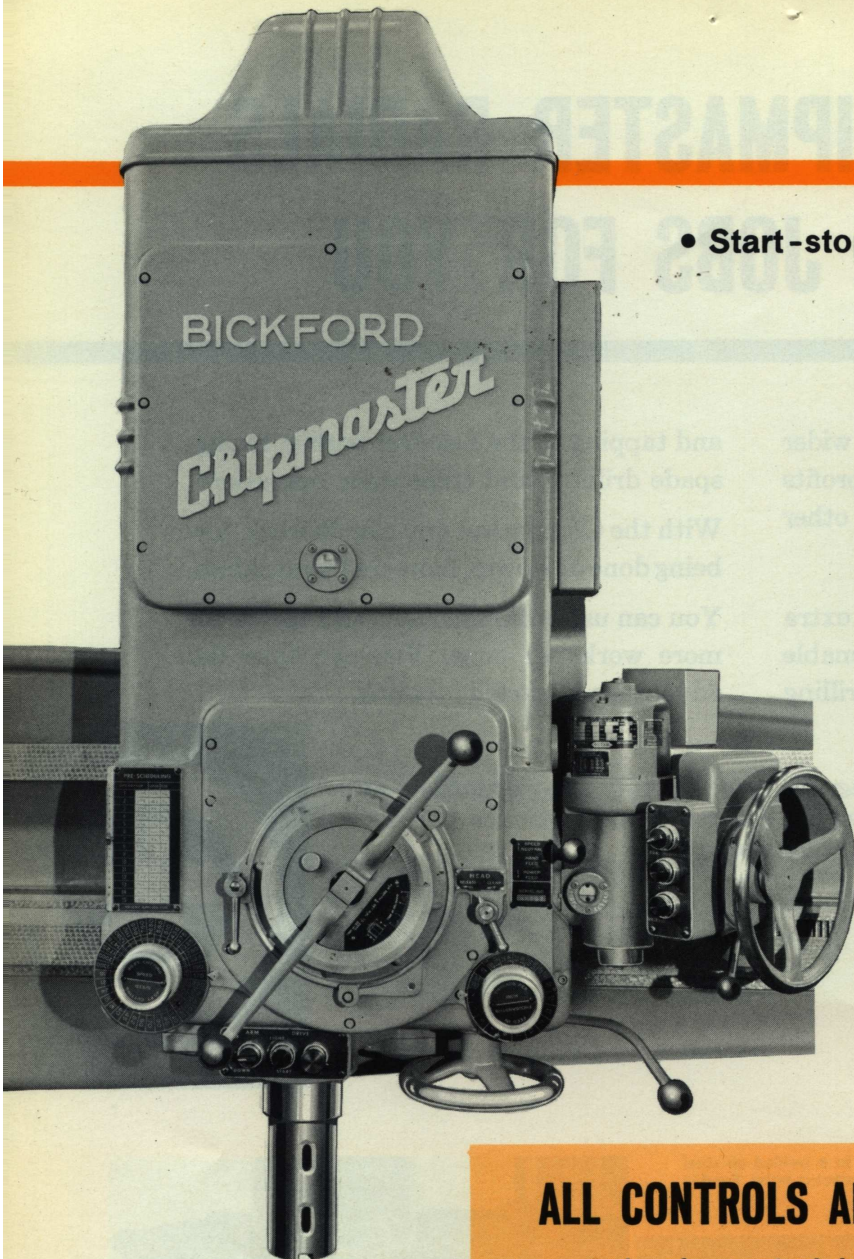

1. Manual Shift

All 36 spindle speeds are changed instantly by two convenient levers mounted low on the left side of the head. Direct-reading speed plate includes drill sizes for 40 and 80 feet per minute cutting speeds, eliminates time-consuming operator calculations. Two levers at lower right of the head control 18 power feeds (.004" to .125"). Six accurate, geared tap leads in three optional ranges are available. Special tap leads can be supplied as an optional extra.

Less handling time . . . more time for machining

All controls on Bickford Chipmaster radials are placed with the operator in mind. As a result, waste motion and machine-handling time are reduced substantially. Any move the operator must make is accomplished through the shortest possible distance and with minimum effort.

ALL CONTROLS ARE CENTRALIZED

. . . only six control buttons operate entire machine

Prescheduling chart—tool diameters, correct spindle speeds, and power feeds for machining operations on each workpiece can be detailed on these handy charts. This arrangement eliminates operator guesswork and increases production efficiency.

Positive mechanical safety lock prevents accidental engagement of power feeds during hand-feed or hand-tapping operations.

Spindle speed dial for preselecting any one of 36 speeds. Black background gives drill diameters and speeds at 80 surface feet per minute; yellow background at 40 feet per minute.

Two bright, sealed beam work lights eliminate shadows, never get hot, are long-lasting, and impervious to damage from chips or coolant.

Power arm elevating and arm clamping—turning selector switch to "Up" unclamps, lubricates, and moves the arm up; turning it to "Down" unclamps, lubricates, and moves arm down. Turning to "Stop" clamps arm automatically. New hydraulically actuated elevating clutch—maintenance-free design never needs adjustment for the life of the machine.

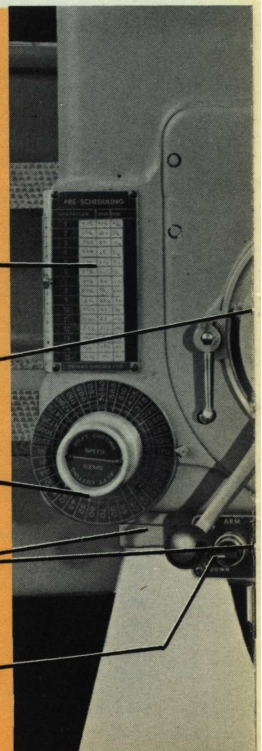

THREE HEAD DESIGNS

- Spindle is completely free of movement or oscillation during shifting, reducing delay in tool changing

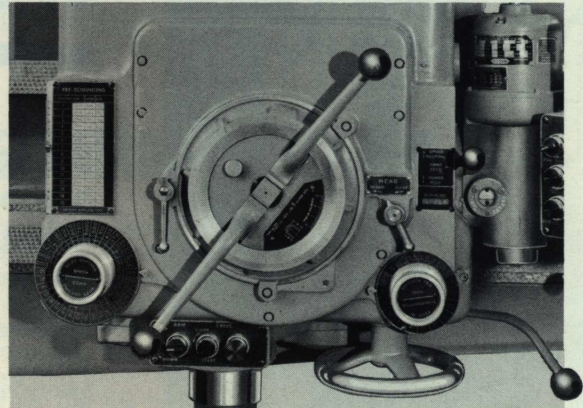
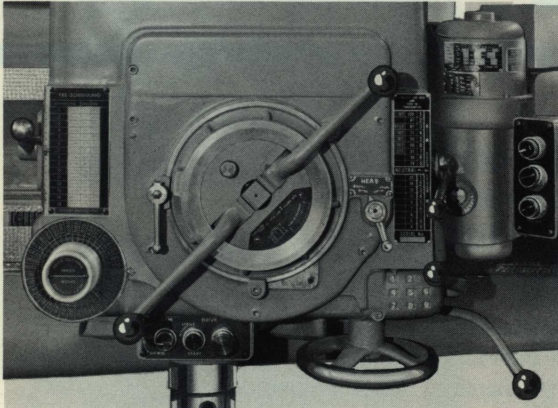

2. Partial Preselect

Spindle speed selector dial at the left side of the head enables the operator to preselect any one of 36 speeds —while machine is in operation. Stopping the spindle automatically shifts machine to preselected speed without spindle oscillation. Two manually operated levers on the right of the head set feed rates. A convenient prescheduling chart above the speed-selector dial can be used to indicate sequence of operations, tools, speeds, and feeds.

3. Full Preselect

Speed and feed selector dials permit preselection of speeds and feeds or any of the positive tap leads. Full hydraulic preselection of speeds and feeds can now be easily accomplished while the machine is under cut. Placing the clutch lever in neutral initiates instant shifting cycle—no movement or oscillation of the spindle during shifting to delay tool changing.

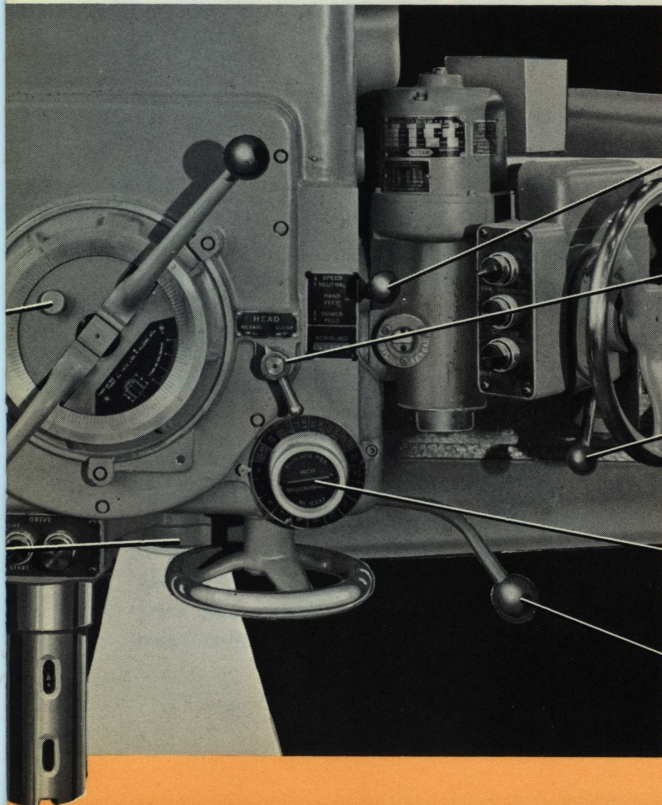

"Neutral" lever disconnects spindle, permits hand-feed operation, enables operator to rotate spindle by hand for indicating and sizing holes.

New hydraulic head clamp operates with fingertip ease by lever on front of head. Selector switch on the pushbutton panel (right) permits clamping column and head simultaneously or independently.

Head traverse control lever automatically disengages traversing wheel, moves head swiftly along the arm in either direction. Disc-type clutch provides positive safety for the head and traverse mechanism, should head, spindle or tool strike an obstruction during traverse.

Feed selector dial for setting 18 power feeds or the positive tap leads. Tap leads on yellow portion of the dial are accurate, positive, geared leads for pipe and standard thread taps.

Clutch control lever for starting, stopping, and reversing spindle engages a multiple-disc driving clutch that is the most powerful used on any radial drilling machine.

MASSIVE ANTIFRICTION SPINDLE

**Spindle is carried in four
preloaded precision bearings
— you can't put too much thrust
on a Chipmaster spindle!**

Bickford 13-19" Chipmaster radials feature a new four-bearing spindle design that provides the extreme rigidity needed for heavy cuts and high production. Three preloaded, angular-contact precision ball bearings support the spindle at the bottom and absorb severe thrust and radial loads produced by heavy drilling and boring. A preloaded precision ball bearing at the top of the spindle absorbs thrust loads from backfacing.

Heavy torque loads are handled without "wind-up" by the high-tensile strength, chrome-nickel alloy steel spindle. The multiple splined spindle drive shaft transfers full effective power from the machine's powerful gear train to the cutting tool.

The spindle noses of the 13" and 15" column Chipmasters are $3\frac{15}{16}$ " in diameter with No. 5 Morse taper shank sockets. Spindle noses for 17" and 19" Chipmasters are $4\frac{3}{16}$ " in diameter with No. 6 Morse taper sockets.

Extra-long spindle sleeve bearing

The massive spindle sleeve is supported in a *honed* head bore over 17" long. Spindle and sleeve feed down together, providing rigid support for the spindle at all times—spindle rigidity is constantly maintained, regardless of its position. This exclusive design feature provides the rigidity necessary for heavy feeds. The feed rack is an integral part of the spindle sleeve. The feed worm-wheel and pinion are directly connected to eliminate backlash and assure accurate tap leads.

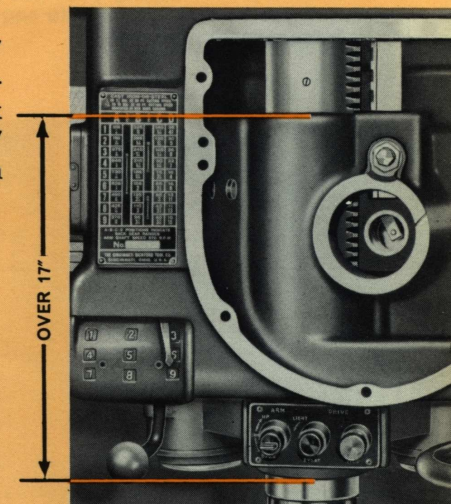
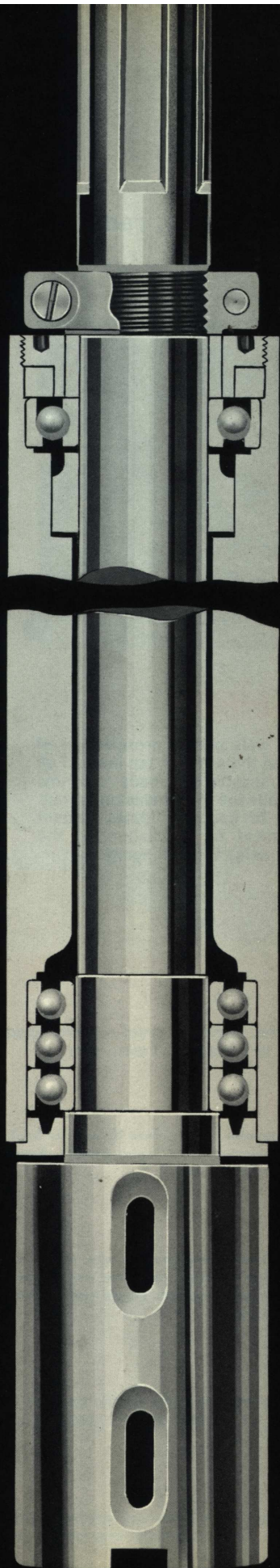

RUGGED SPEED TRAIN

... only 17 gears, 4 gear centers required to provide 36 spindle speeds

The exclusive herringbone final drive gear of Bickford Chipmaster radials helps make them the most powerful radial on the market. Final drive for the 18 lower spindle speeds is through this rugged gear, providing the extra power needed for heavy loads. Final drive for smaller drills and taps is through a high-speed spur gear. The herringbone gear is declutched automatically.

All gears are manufactured from alloy steel stock and are heat-treated, shaved, hardened, and honed to exact tolerances, for sustained quiet running at high spindle speeds. Heat-treated, stress-relieved shafts are multiple-splined and revolve in antifriction bearings.

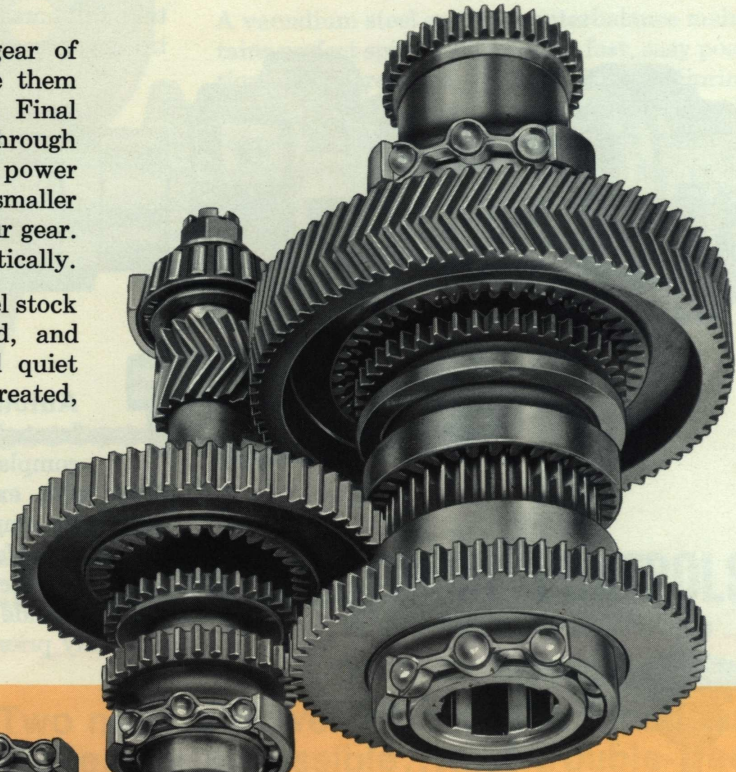

Flywheel effect eliminated

At higher spindle speeds required for small drills and taps the herringbone gear is free to idle on its bearings, never exceeding 500 surface feet per minute. This eliminates the flywheel effect normally found on other radials. Instantaneous spindle reversing at maximum speeds also is possible—a real timesaver on tapping operations.

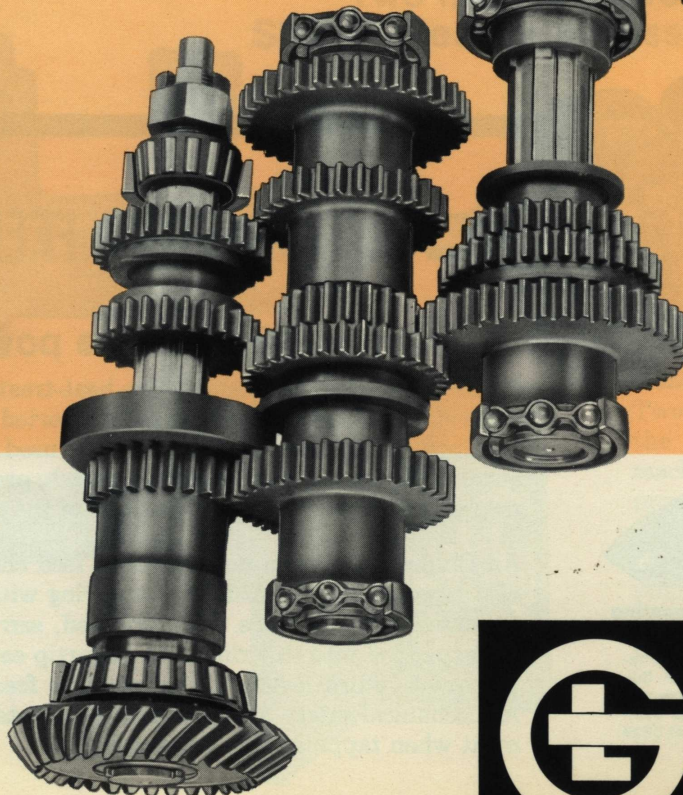
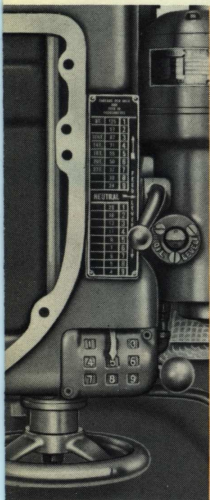



MAIN DRIVE CLUTCH

Heart of the Chipmaster Radial

The most powerful driving clutch on any radial—built to take full horsepower for heavy cuts, yet sensitive to fingertip engagement for high-speed drilling and tapping operations. The clutch is mounted on a one-piece Parko-lubricized steel sleeve and carried in the clutch housing on anti-friction bearings. It is roller actuated and cushioned to absorb the sudden shocks of countless starts and reversals. It runs in oil, which provides complete lubrication.

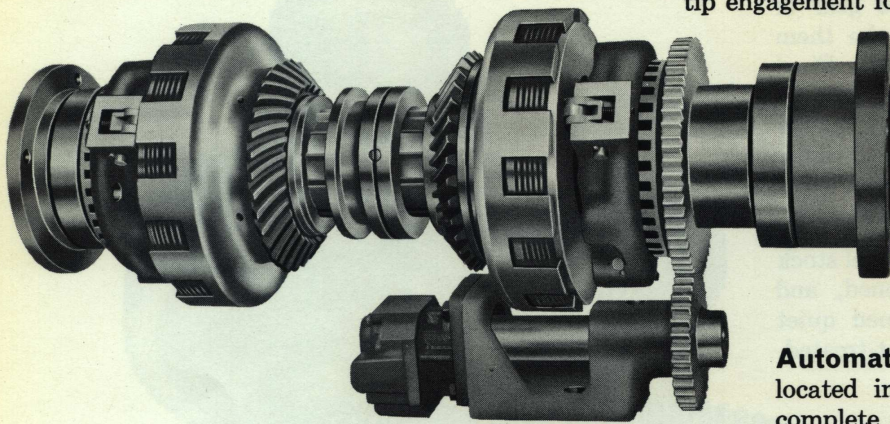

Automatic lubrication. A gear-driven pump, located in the driving clutch reservoir, provides complete effective lubrication to the head. An oil filter, with extra capacity, gives added protection and assures an ample supply of clean oil to all gears, bearings, and wear surfaces on the head. Power rapid traverse unit, elevating clutch, and motor gears run in oil. Arm-elevating nut and inside the arm barrel are pressure-lubricated automatically prior to any vertical movement of the arm.

COMPACT FEED TRAIN

... provides 18 accurate power feeds

Gears in the feed mechanism are heat-treated alloy steel. Each shaft is multiple-splined and supported in antifriction bearings—no springs or drive keys are used. A safety feed gear, incorporating a multiple-disc clutch, protects the head mechanism from accidental overload of the power feed.

All Chipmasters use a positive-drive feed clutch consisting of a large-diameter, hardened steel ring with serration on the inner circumference. Two opposed, serrated segments are expanded into this ring with fingertip ease by either of the quick-return levers, giving positive feed engagement. A mechanical safety lock prevents accidental feed engagement when tapping with a free spindle.

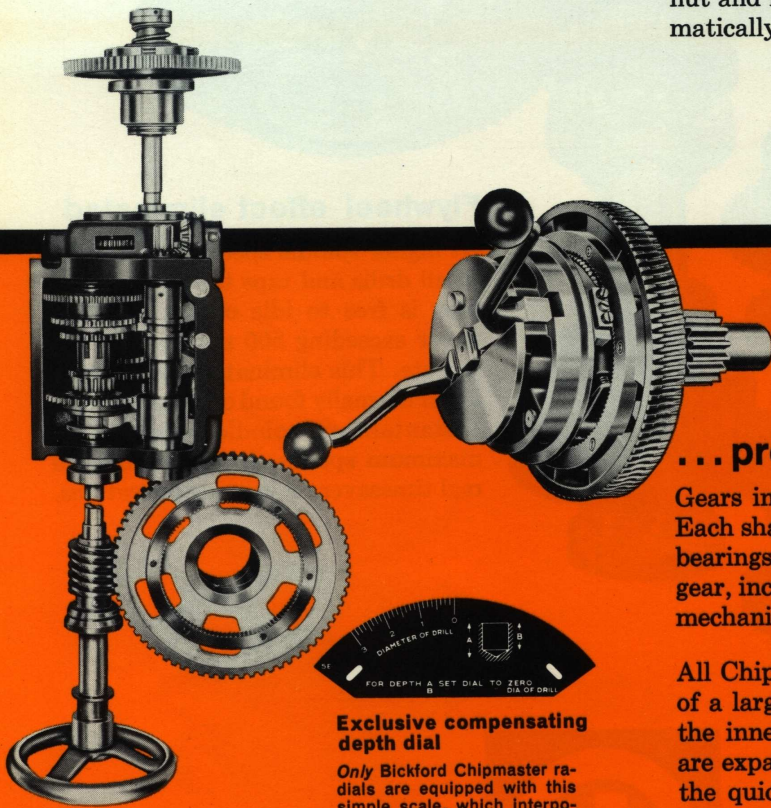

Exclusive compensating depth dial

Only Bickford Chipmaster radials are equipped with this simple scale, which interpolates depth readings to compensate for the point or cone of the drill.

SPINDLE COUNTERBALANCE

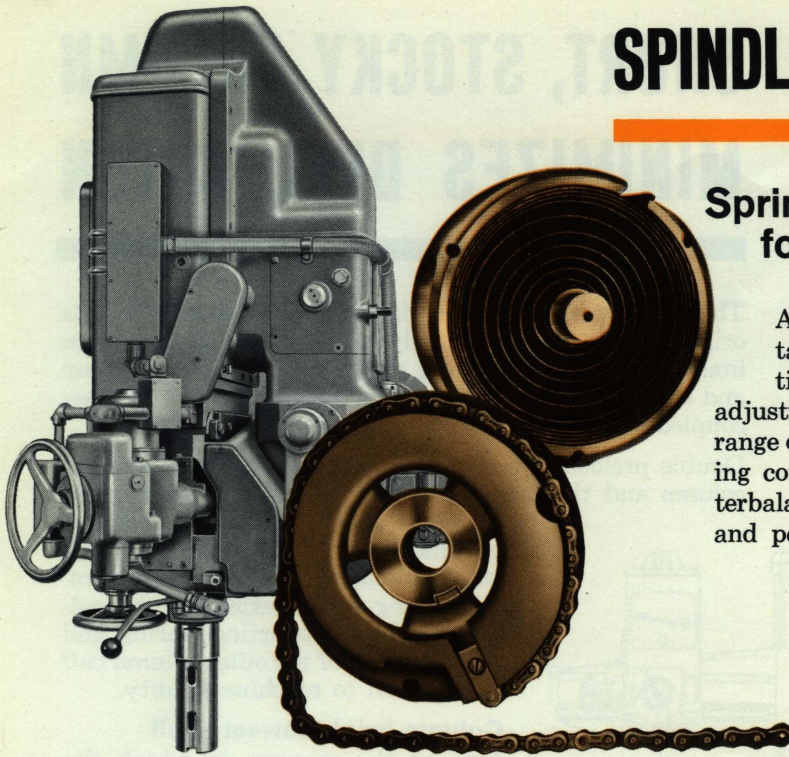

Spring adjustment compensates for heavy or lightweight tools

A vanadium steel spring counterbalance maintains perfect spindle balance for fast, easy positioning and reduced operator fatigue. Spring adjustment feature easily compensates for a wide range of cutting tool sizes and weights. By eliminating conventional bulky counterweights, the counterbalance spring reduces the weight of the head, and permits faster, easier machine manipulation.

CENTRALIZED ELECTRICAL CONTROLS

Two motors power all machine functions Simple...easily accessible...and trouble-free

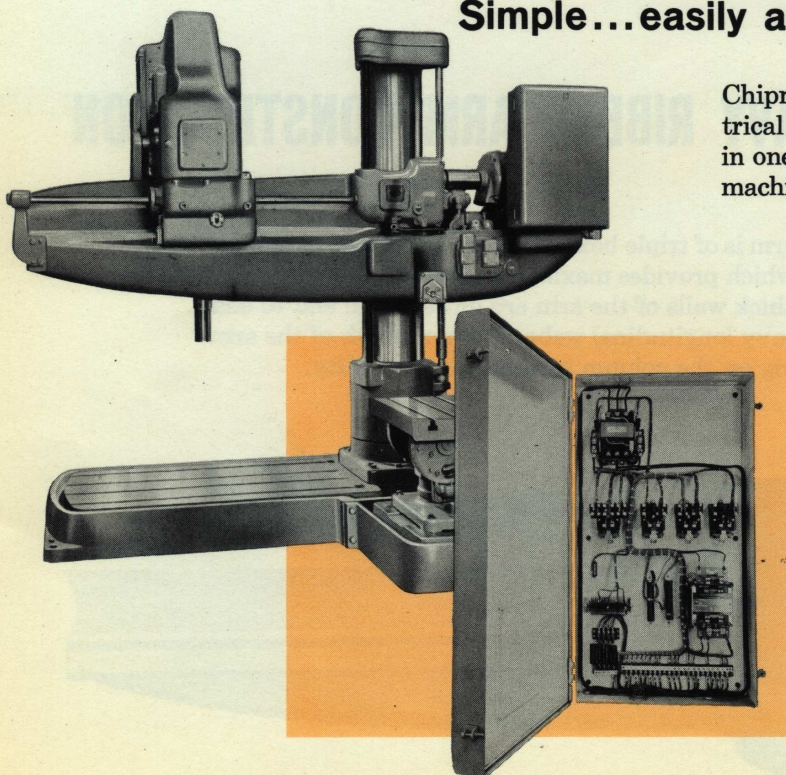

Chipmaster radials feature an easy-to-maintain electrical system—all electrical contactors are grouped in one NEMA Type 12 enclosure at the rear of the machine. Ample transformer capacity provides 110-volt power for all pushbuttons, solenoids, and 6-volt machine work lights. All electrical connections to the head are made in a terminal box at the side of the head. Terminals are number-coded for easy identification.

Two electric motors—the main drive and the head traverse motors—power *all* machine functions. The main drive motor provides full horsepower at the spindle and operates the arm-elevating mechanism and hydraulic clamping. This simplified arrangement eliminates the many independent motors and starters required by other radial drilling machines.

All electrics and hydraulics meet or exceed JIC standards.

SHORT, STOCKY COLUMN MINIMIZES DEFLECTION

The superior strength and rigidity of Chipmaster radials originate from their unusually rugged columns. One-piece inner column construction, extra-thick walls on column and sleeve, and reduced column height provide a close-coupled "one-piece" design that resists deflection.

Double preloaded taper bearings at the top of the inner column and the large precision preloaded taper bearing mounted above the clamping flange on the inner trunk provide extra strength and resistance to deflection. Extra-long arm bearing on the column, the long supporting bearing, and full thickness of the outer column cuff further add to machine rigidity.

Column height lowest of all

Due to the manner in which the Chipmaster head is mounted, column height is as much as $17\frac{1}{8}$ " less than other radials—without sacrificing work height between spindle and base. The resulting short rigid column resists deflection imposed by the heaviest thrust loads.

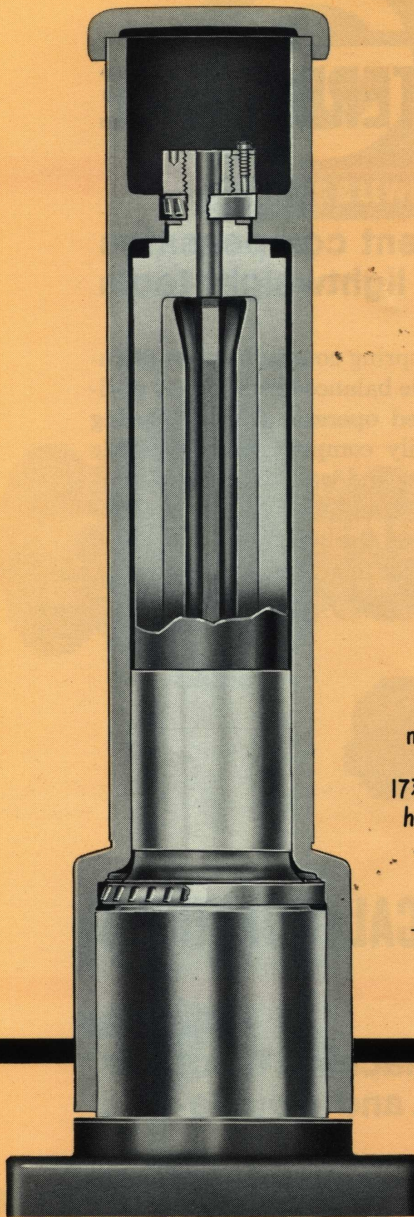
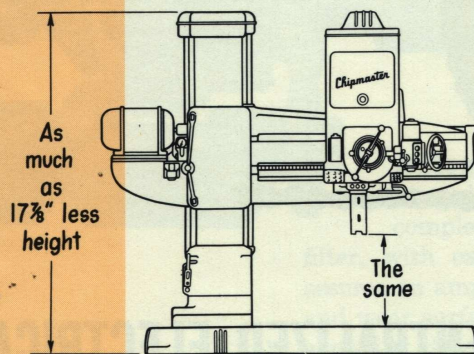

HEAVY RIBBED ARM CONSTRUCTION

The arm is of triple box-section heavy ribbed construction which provides maximum resistance to deflection. The thick walls of the arm are united from end to end by heavy longitudinal webs. Greater length of the arm bearing on the column assures added rigidity.

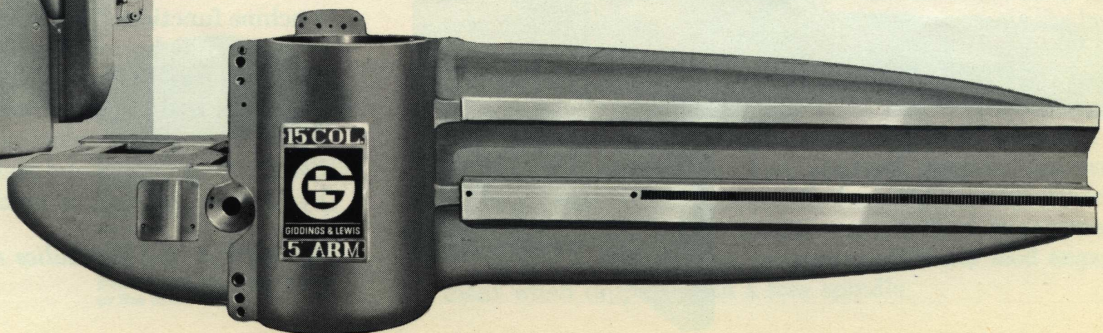
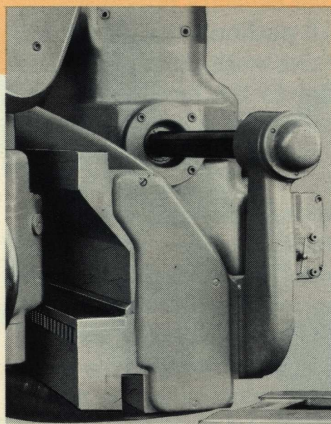

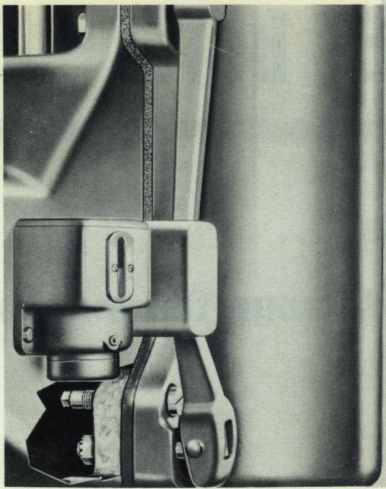

AUTOMATIC POWER ARM AND COLUMN CLAMPING

Hydraulic clamping mechanism locks column sleeve to main column, applying up to 75,000 lb clamping pressure. Hydraulic arm and column clamping are quickly and easily actuated at the head by a push-button, or by the head control clamping lever.

ARM-ELEVATING MECHANISM

Power for the arm-elevating mechanism is transmitted by a hydraulically actuated multiple-disc clutch, which engages automatically when the selector switch on the head is actuated. Clutch is maintenance-free and never needs adjustment during the life of the machine. A safety nut in the arm-elevating mechanism provides foolproof protection against the arm's dropping due to failure of the main elevating nut. The safety nut easily supports the full arm load, safeguarding operator, machine, and workpiece.

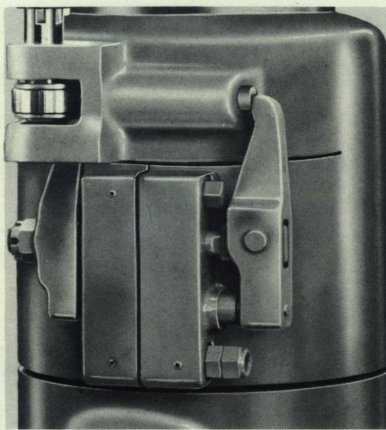
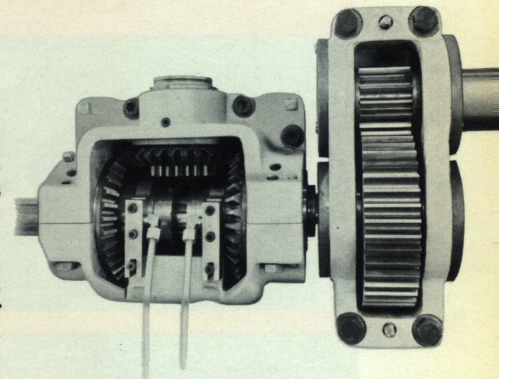

RUGGED CONSTRUCTION ASSURES RIGIDITY

Rugged column trunk stays put

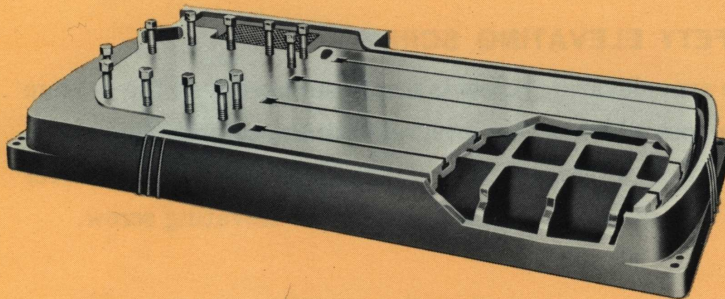

From base to spindle, Chipmaster radials are the most rugged machines on the market. Base (left) is a single semisteel casting. Closely spaced transverse and longitudinal ribs under the base take the shock loads and vibration generated by heavy thrust loads. Coolant sump is an integral part of the base.

See page 16 for optional base arrangements.

Heavy ribbed base distributes loading evenly

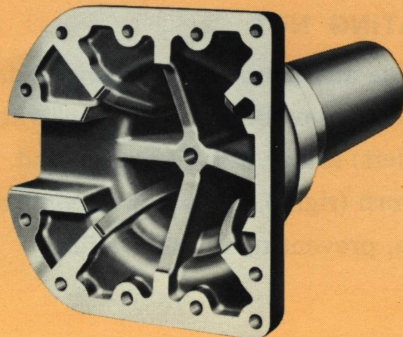

Heavy internal ribs reinforce the entire length of the extra-thick inner column trunk. The bottom of the inner column is machined simultaneously with clamping surface and support bearing diameters so inner column is absolutely perpendicular to the base. *No shims are permitted during final assembly.*

THE SAFEST RADIALS EVER BUILT

the arm can't drop... the spindle can't fall...

overloads or obstructions can't damage the machine!

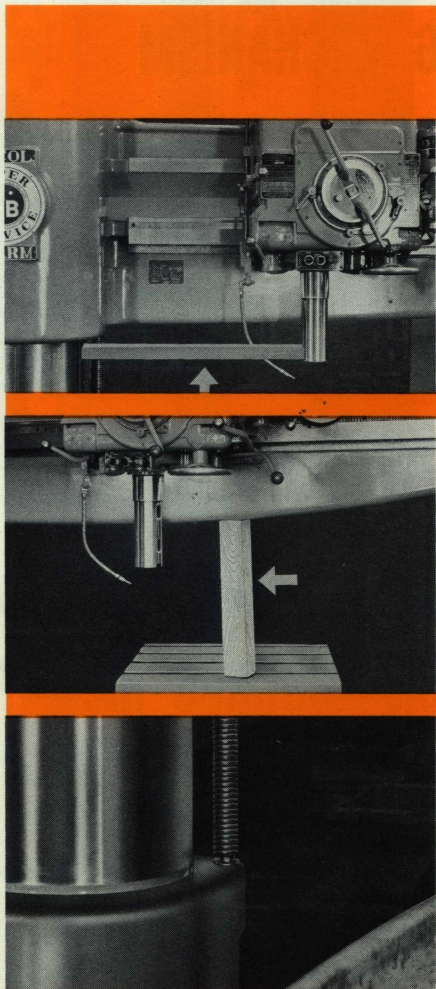

TRAVERSE PROTECTION

This demonstration proves there's absolutely no damage to machine if the head, spindle, or tool strikes an obstruction. A multiple disc clutch, running in a bath of oil, provides complete safety to the head and traverse mechanism.

SAFETY LIMITS ON ARM TRAVEL

Limit switches stop the arm at uppermost position, and a torque limiting clutch prevents damage should the arm travel into an obstruction in its downward motion. This arrangement increases operator confidence and speeds machine operation.

SAFETY ELEVATING SCREW

The arm elevating screw is firmly supported at the bottom by a boss which is cast integral with the column sleeve cuff. With this design, you are assured that the arm can never fall, regardless of the condition of the elevating screw.

SAFETY ELEVATING NUT

The safety elevating nut is provided to prevent damage due to failure of the main elevating nut. With elevating nut in normal position (left) safety nut carries no load. If threads of main nut are worn (right) safety nut disconnects, carries weight of the arm, preventing it from falling.

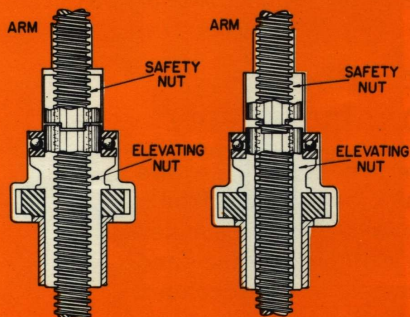

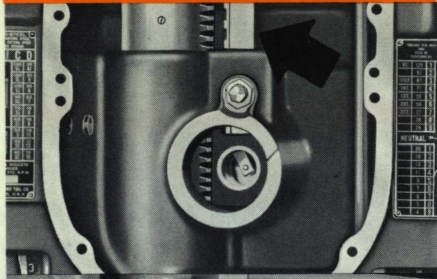

SPINDLE CAN'T FALL

Patented safety catch prevents the spindle from falling should the counterbalance spring or chain fail. A plunger snaps into a notched guide bar preventing the spindle from falling.

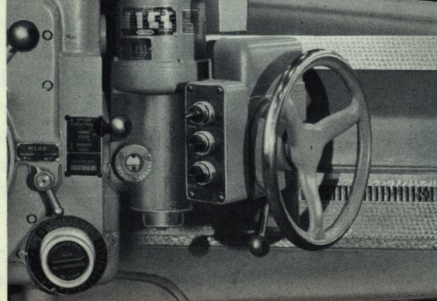

HANDWHEEL DOES NOT ROTATE WHEN HEAD IS TRAVERSING

Head is traversed by an independent electric motor actuated by a lever on the head. When power traverse is operated, the head-moving handwheel is disconnected automatically and does not revolve—an important safety feature.

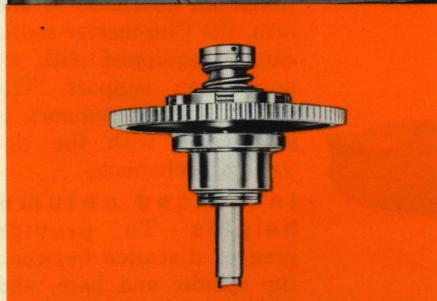

FEED OVERLOAD CLUTCH

A safety feed gear, incorporating a multiple-disc clutch running in a bath of oil protects the head mechanism from accidental overload of power feed. Clutch is maintenance-free and needs no adjustment for the life of the machine.

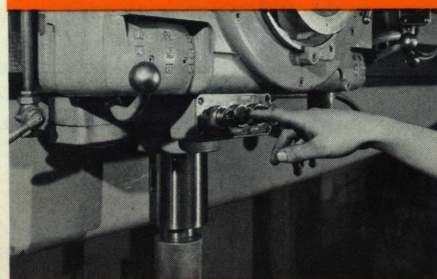

SAFETY STOP BUTTON

This red mushroom button is conveniently located on the head immediately above the spindle within easy reach of the operator. Depressing the button instantly stops the entire machine and engages column clamp automatically—before damage can occur.

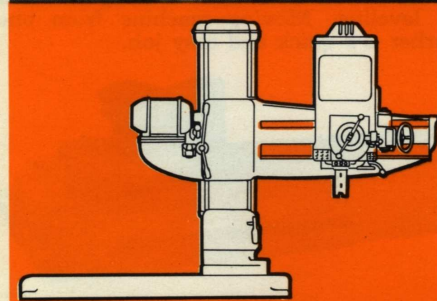

MACHINE WON'T TIP OVER

Short column keeps machine weight close to the floor. The arm can be fully elevated and swung 360° with the head at the extreme end of the arm without danger of tipping.

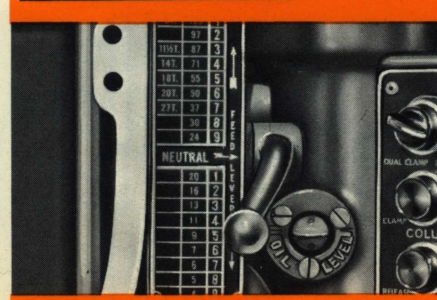

POSITIVE NEUTRAL FOR HAND FEEDING SPINDLE

Lever at side of head puts spindle in neutral so that the spindle can be controlled manually.

OPTIONAL CHIPMASTER FEATURES

Track-type Chipmaster radial is of unusually heavy construction and provided with hardened steel wheels for traveling on 80-lb rail with $56\frac{1}{2}$ " standard railway gage. For lighter machines, a similar but smaller base using 36" gage 40-lb rails also is available. Power traverse and equalized power clamping to the rails are by individual motors.

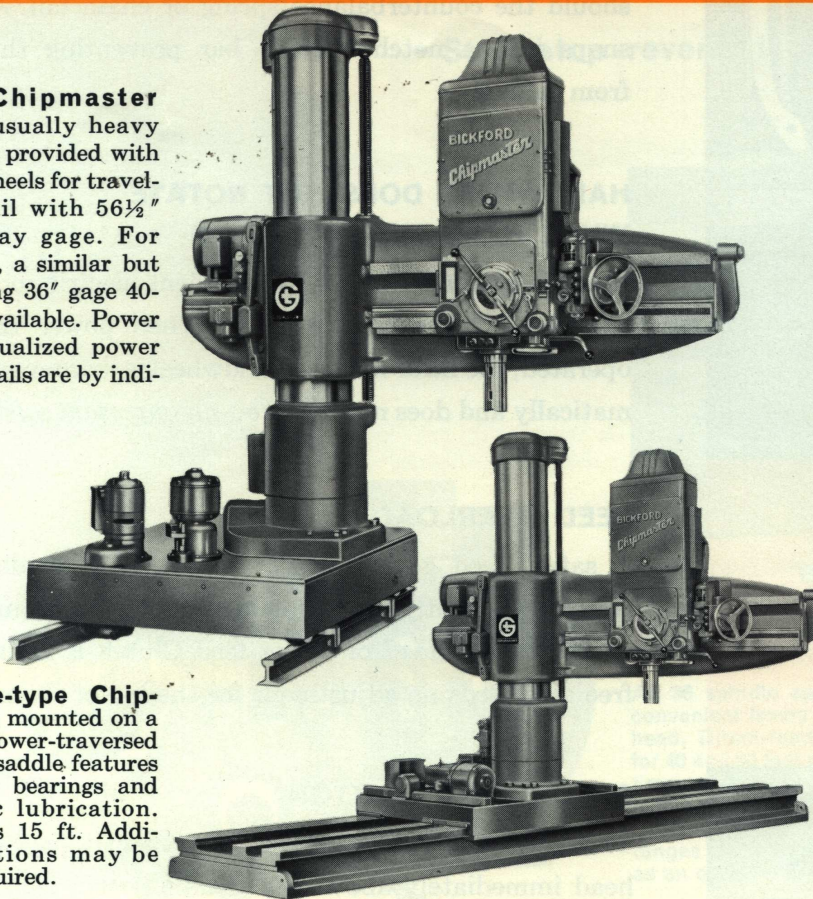

Sliding saddle-type Chipmaster radial is mounted on a saddle which is power-traversed on the bed. The saddle features nonmetallic way bearings and fully automatic lubrication. Normal travel is 15 ft. Additional bed sections may be added where required.

Lifting bail—Chipmaster radials can be equipped with heavy steel cap and sturdy lifting hook mounted on cap. This will permit picking up of machine with crane hooks . . . hold machine at level without blocking or rigging . . . allow machine to be readily moved from place to place.

Outer arm support—Where the job demands minimum deflection of the arm, the Chipmaster radial can be equipped with an outer arm support. The clamp on this support is interlocked with the elevating mechanism.

Increased column heights—To provide greater distance between the spindle and base, and still maintain the minimum standard distance to base, the column and sleeve can be lengthened to meet customer's specified requirements.

OPTIONAL BASES AVAILABLE

Pad at back of base is machined for adding a right-angle or table extension base at any time. Holes are provided for leveling and hold-down screws eliminating the need of wedges for leveling. Moving machine from one location to another is a quick and easy job.

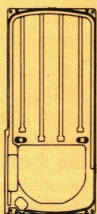

STANDARD BASE

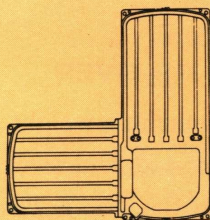

RIGHT-ANGLE BASE

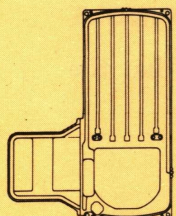
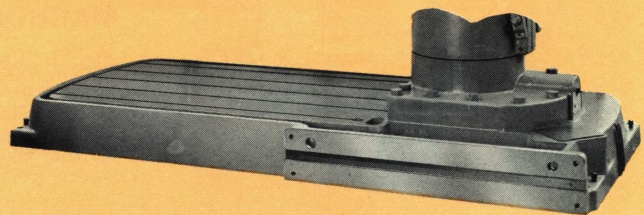
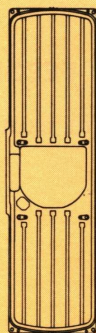
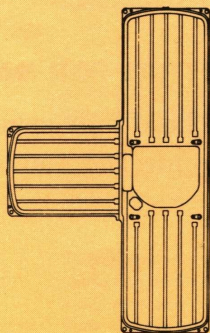

TABLE EXTENSION BASE



DOUBLE-END BASE



TRIPLE-END BASE

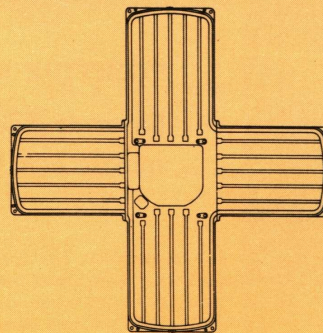

FOUR-WAY BASE

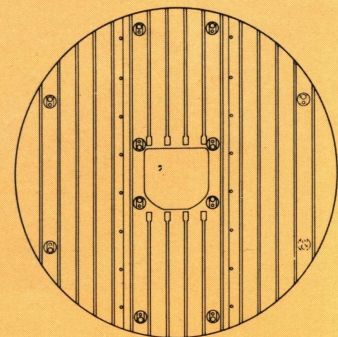

FULL-ROUND OR HALF-ROUND BASES

SETUP ACCESSORIES

Indexing trunnion and outboard support—For easier and faster handling of small and large jigs or fixtures. Trunnion indexes in 90° increments. Standard unit is available in two sizes and can be easily mounted on a standard radial drill base. Some of the major advantages of the indexing trunnion stand are:

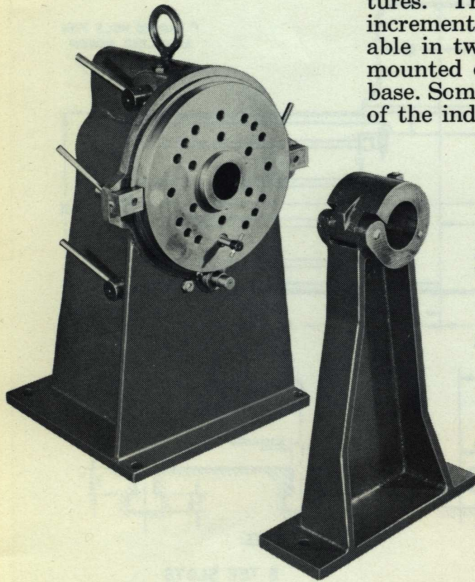

1. Work is placed at a comfortable height and operator can perform several operations in a single setup, increasing efficiency.
2. Setup is fast and easy. Workpiece can be easily rotated for various operations in two planes.
3. Because jigs can be indexed, a single jig can replace two or more that can be used only in a single plane.
4. Fewer jigs require less storage space . . . less loading and unloading of workpiece.
5. Machining costs on many workpieces can be reduced as much as 75% .

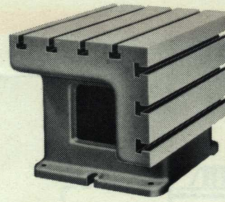

Plain table—Plain table has a large working surface on top and a narrow surface on one side. It has a strong box-type construction and T-slots are planed from the solid.

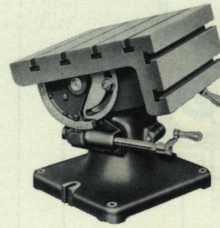

Universal tilting tables—Rectangular top can be rotated 360° and tilted 90°. Limit stops position the table in the horizontal and vertical planes and a powerful, single-lever clamp maintains angular settings.

Universal table also can be supplied with a large, revolving round top.

STANDARD AND SPECIAL DAVIS TOOLING

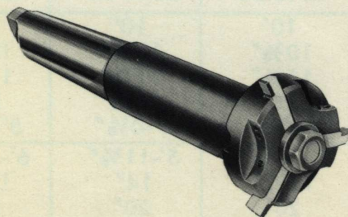

"Kwik-Size"—A single head that indexes for rough semifinish and finish boring . . . eliminates the need for separate tools for each operation, reduces tool-change time, increases output, cuts cost. Three series, 18 sizes to cover bore range from 3 to 13½" in diameter. Available with Morse, M.M., and G&L quick-change taper shanks, as well as straight shanks.

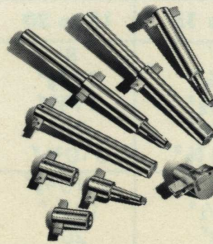

Precision boring bars—Standard sizes available from ¼ to 12" in diameter, with a choice of block-type or flycutter slots, all types of shanks, heat-treated or case-hardened finishes. Custom lengths and arrangements to meet all machining requirements.

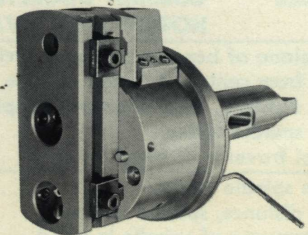

"CF" continuous feed heads—4", 6", and 10" body diameters for boring, facing, turning, counterboring, backfacing, grooving, and chamfering operations to a recommended maximum bore diameter of 25".

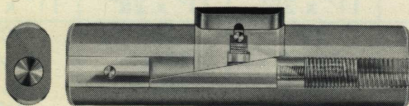

Adjustable drawkey—For tools, boring bars, and arbors with Morse taper shanks; patented expanding-wedge design draws taper straight back in spindle, provides faster, easier, more positive locking and eliminates damage from hammering.

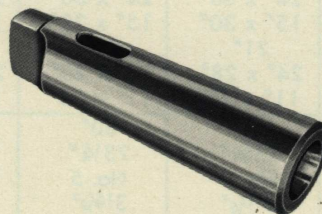

Adapter sleeves—For Morse taper and G&L quick-change type shanks. Available in Brown & Sharpe and Morse taper socket designs to accommodate shank-type end mills, drills, taps, and reamers. Precision-ground to assure vibration-free drive.

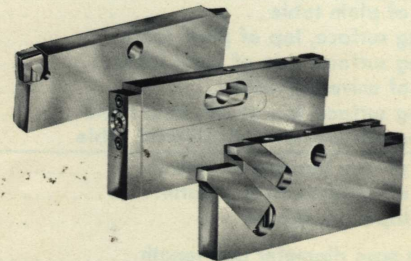

Block tooling—Two-cutter expandable and throwaway tip, single-cutter micrometer-adjustable expandable throwaway tip, multicutter, and solid-block cutter types—¼ to 17" bore diameter.

13"-19" CHIPMASTER Specifications

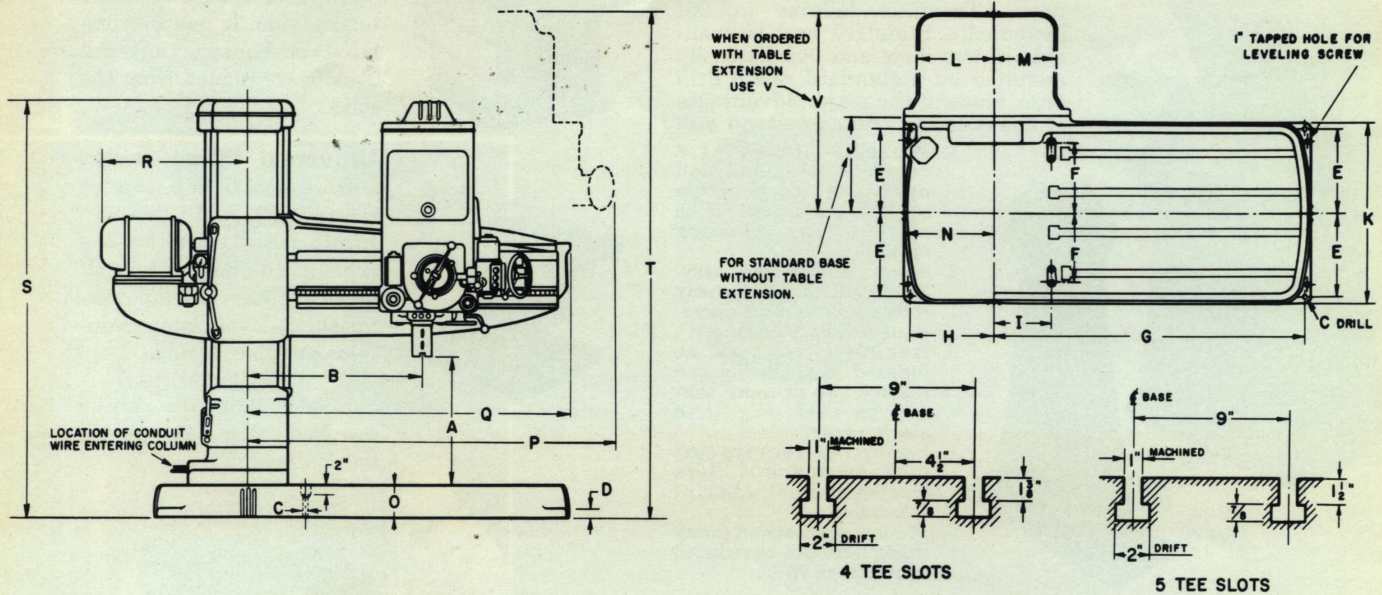

SIZE	ARM LENGTH COLUMN DIAMETER HORSEPOWER AVAILABLE	4-FOOT		5-FOOT			
		13"	15"	13"	15"	17"	15"
		10 to 15	15 to 20	10 to 15	15 to 20	20 to 25	15 to 20
Drills in plane of base to center of circle of		8'	8'	10'	10'	10'	12'
Distance from center of column to face of column		9 1/8"	10 3/8"	9 1/8"	10 3/8"	11 5/8"	10 3/8"
Minimum distance, face of column to spindle		12 1/8"	11 5/8"	12 1/8"	11 5/8"	11 7/8"	11 5/8"
Minimum spindle radius		21 1/4"	22"	21 1/4"	22"	23 1/2"	22"
Horizontal traverse of head on arm		2'-11 7/8"	3'-0 3/8"	3'-11 7/8"	4'-0 3/8"	4'-0 1/8"	5'-0 3/8"
Maximum spindle radius		4'-9 1/8"	4'-10 3/8"	5'-9 1/8"	5'-10 3/8"	5'-11 5/8"	6'-10 3/8"
Minimum distance, spindle to base		11 1/2"	12 1/2"	11 1/2"	12 1/2"	14"	12 1/2"
Vertical traverse of spindle in head		20"	20"	20"	20"	20"	20"
Vertical traverse of arm on column		2'-6 1/2"	2'-11 1/2"	2'-6 1/2"	2'-11 1/2"	3'-2"	2'-11 1/2"
Maximum distance, spindle to base		5'-0"	5'-6"	5'-0"	5'-6"	6'	5'-6"
Extreme height of head above floor		10'-10"	11'-4"	10'-10"	11'-4"	12'-3"	11'-4"
Extreme height of column above floor		8'-9"	9'-3"	8'-9"	9'-3"	10'-4"	9'-3"
Height of base		9"	9"	9"	9"	10"	9"
Working surface of base		3'-6" x 4'-11"	3'-6" x 4'-11"	3'-6" x 5'-11"	3'-6" x 5'-11"	4'-2" x 5'-11"	3'-6" x 6'-11"
Height of plain table		20"	20"	20"	20"	20"	20"
Working surface, top of plain table		24" x 30"	24" x 30"	24" x 30"	24" x 30"	24" x 30"	24" x 30"
Working surface, side of plain table		15" x 30"	15" x 30"	15" x 30"	15" x 30"	15" x 30"	15" x 30"
Height of universal table		21"	21"	21"	21"	21"	21"
Working surface, top of universal table		24" x 28"	24" x 28"	24" x 28"	24" x 28"	24" x 28"	24" x 28"
Working surface, side of universal table		11" x 28"	11" x 28"	11" x 28"	11" x 28"	11" x 28"	11" x 28"
Length of arm bearing on column		28"	30"	28"	30"	34"	30"
Length of head bearing on arm		23 1/4"	23 1/4"	23 1/4"	23 1/4"	23 1/4"	23 1/4"
Morse taper in spindle		No. 5	No. 5	No. 5	No. 5	No. 6	No. 5
Spindle nose diameter and length		3 1/16" x 7 1/8"	3 1/16" x 7 1/8"	3 1/16" x 7 1/8"	3 1/16" x 7 1/8"	4 3/16" x 9 7/16"	3 1/16" x 7 1/8"
Diameter of spindle, least section		2 1/2"	2 1/2"	2 1/2"	2 1/2"	2 1/2"	2 1/2"
Approximate floor space		10'-10" x 14'-11"	11'-3" x 15'-2"	11'-10" x 16'-11"	12'-3" x 17'-2"	12'-6" x 17'-6"	13'-3" x 19'-2"
Net weight of machine without table (lb.)		14200	15600	15200	16600	20900	17600
Shipping weight of machine without table (lb.)		14500	15850	15500	16850	21200	17850
Shipping weight of plain table (lb.)		950	950	950	950	950	950
Shipping weight of universal table (lb.)		1100	1100	1100	1100	1100	1100

SIZE		A		B		C	D	E	F	G	H	I	J	K	L	M	N	O	P		Q	R	S	T	V	Tee Slot
Arm	Dia. of Col.	Min.	Max.	Min.	Max.														Hand Trav.	Power Trav.						
4 ft.	13"	11½"	60"	21¼"	57½"	1½"	2¾"	20¼"	14½"	67¾"	21¼"	10¼"	24½"	44"	16½"	19½"	23"	9"	87½"	89¾"	77½"	45"	105"	130"	59¾"	X
5 ft.	13"	11½"	60"	21¼"	69¾"	1½"	2¾"	20¼"	14½"	79¾"	21¼"	10¼"	24½"	44"	16½"	19½"	23"	9"	99¾"	101¾"	89½"	45"	105"	130"	59¾"	X
4 ft.	15"	12½"	66"	22"	58¾"	1½"	2¾"	20¼"	14½"	68¾"	20"	11½"	24½"	44"	14¾"	20¾"	21¼"	9"	88¾"	90¾"	78¾"	45"	111"	136"	59¾"	X
5 ft.	15"	12½"	66"	22"	70¾"	1½"	2¾"	20¼"	14½"	80¾"	20"	11½"	24½"	44"	14¾"	20¾"	21¼"	9"	100¾"	102¾"	90¾"	45"	111"	136"	59¾"	X
6 ft.	15"	12½"	66"	22"	82¾"	1½"	2¾"	20¼"	14½"	92¾"	20"	11½"	24½"	44"	14¾"	20¾"	21¼"	9"	112¾"	114¾"	102¾"	45"	111"	136"	59¾"	X
5 ft.	17"	14"	72"	23½"	71½"	1¼"	3½"	24"	19¾"	81¾"	28¾"	13"	28½"	52"	22"	20¾"	30¾"	10"	102¾"	104¾"	92"	47"	124"	147"	64"	Y
6 ft.	17"	14"	72"	23½"	83¾"	1¼"	3½"	24"	19¾"	93¾"	28¾"	13"	28½"	52"	22"	20¾"	30¾"	10"	114¾"	116¾"	104"	47"	124"	147"	64"	Y
7 ft.	17"	14"	72"	23½"	95¾"	1¼"	3½"	24"	19¾"	105¾"	28¾"	13"	28½"	52"	22"	20¾"	30¾"	10"	126¾"	128¾"	116"	47"	124"	147"	64"	Y
6 ft.	19"	16"	78"	24¾"	85"	1¼"	3½"	24"	19¾"	95"	27"	14¾"	28½"	52"	20¾"	22"	29"	10"	115¾"	118"	106"	48"	130"	153"	64"	Y
7 ft.	19"	16"	78"	24¾"	97"	1¼"	3½"	24"	19¾"	107"	27"	14¾"	28½"	52"	20¾"	22"	29"	10"	127¾"	130"	118"	48"	130"	153"	64"	Y
8 ft.	19"	16"	78"	24¾"	109"	1¼"	3½"	24"	19¾"	119"	27"	14¾"	28½"	52"	20¾"	22"	29"	10"	139¾"	142"	130"	48"	130"	153"	64"	Y

6-FOOT		7-FOOT		8-FOOT
17"	19"	17"	19"	19"
20 to 25	20 to 30	20 to 25	20 to 30	20 to 30
12'	12'	14'	14'	16'
11 5/8"	13"	11 5/8"	13"	13"
11 1/8"	11 5/8"	11 7/8"	11 5/8"	11 5/8"
23 1/2"	24 3/8"	23 1/2"	24 3/8"	24 5/8"
5'-0 1/8"	5'-0 3/8"	6'-0 1/8"	6'-0 3/8"	7'-0 3/8"
6'-11 5/8"	7'-1"	7'-11 5/8"	8'-1"	9'-1"
14"	16"	14"	16"	16"
20"	20"	20"	20"	20"
3'-2"	3'-6"	3'-2"	3'-6"	3'-6"
6'	6'-6"	6'	6'-6"	6'-6"
12'-3"	12'-9"	12'-3"	12'-9"	12'-9"
10'-4"	10'-10"	10'-4"	10'-10"	10'-10"
10"	10"	10"	10"	10"
4'-2"	4'-2"	4'-2"	4'-2"	4'-2"
x 6'-11"	x 6'-11"	x 7'-11"	x 7'-11"	x 8'-11"
20"	20"	20"	20"	20"
24" x 30"	26" x 33"	24" x 30"	26" x 33"	26" x 33"
15" x 30"	17" x 33"	15" x 30"	17" x 33"	17" x 33"
21"	22"	21"	22"	22"
24" x 28"	28" x 32"	24" x 28"	28" x 32"	28" x 32"
11" x 28"	12" x 32"	11" x 28"	12" x 32"	12" x 32"
34"	38"	34"	38"	38"
23 1/4"	23 1/4"	23 1/4"	23 1/4"	23 1/4"
No. 6	No. 6	No. 6	No. 6	No. 6
4 3/16"	4 3/16"	4 3/16"	4 3/16"	4 3/16"
x 9 7/16"	x 9 7/16"	x 9 7/16"	x 9 7/16"	x 9 7/16"
2 1/2"	2 1/2"	2 1/2"	2 1/2"	2 1/2"
13'-6"	14' x	14'-6"	15' x	16' x
x 19'-6"	19'-8"	x 21'-6"	21'-8"	23'-8"
22000	24400	23100	25600	26800
22300	24800	23500	26100	27300
950	1100	950	1100	1100
1100	1675	1100	1675	1675

TYPE OF DRIVE, MOTOR-SPEED RANGE AND EXTRA EQUIPMENT

SPINDLE SPEEDS—The purchaser of 13-19" Chipmaster Radials has his choice of any one of the following spindle speed ranges:

Min. Spindle Speed		Max. Spindle Speed
8 rpm	Available on machines with 1200-rpm motors only	1000 rpm
10 rpm		1250 rpm
12 rpm	Available on machines with 1200 or 1800-rpm motors	1500 rpm
14 rpm		1750 rpm
18 rpm		2300 rpm

It is suggested that a 1200-rpm constant speed driving motor be purchased.

NOTE—If the machine is for use on 25-cycle or 50-cycle alternating current, the motor speed should be 750 rpm or 1000 rpm to obtain the lowest range offered on each size. For the other speed ranges use a 1000 or 1500-rpm motor.

FEEDS—There are 18 power feeds ranging from .004" to .125" per revolution. These include tap leads of 8, 11½, 14, 18, 20, and 27 threads per inch. When specified, either one of the following alternate tap lead ranges can be supplied at no extra charge in lieu of above: 8, 10, 12, 14, and 27 threads per inch, or 8, 10, 11½, 14, 20, and 27 threads per inch.

STANDARD EQUIPMENT includes power arm elevation, hydraulic arm and column clamping controlled at the head, power rapid head traverse, dual electric lights at spindle, standard driving and retaining slots in the spindle nose and all wiring and electrical equipment except the driving motor and control. Power head clamping is standard on Chipmasters with full and partial preselect heads, optional on manually operated machines.

EXTRA EQUIPMENT includes: cutting lubricant system, plain or universal table, extension to base for table, special bases, lengthened columns and spindle nose alterations.

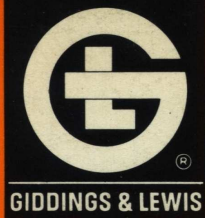

DRILLING MACHINES

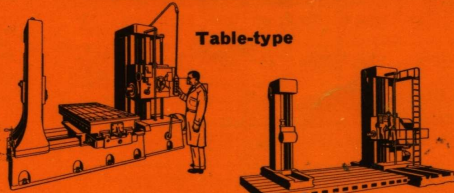

Table-type



Floor-type



Planer-type

HORIZONTALS

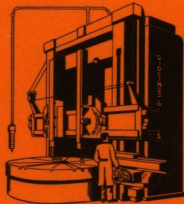

VERTICAL BORING MILLS

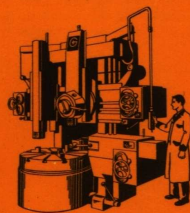

VERTICAL TURRET LATHES

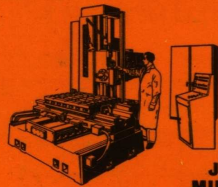

JIG BORER AND MILLING MACHINES

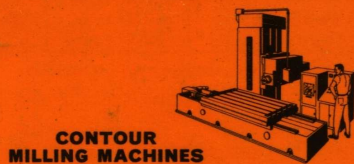

CONTOUR MILLING MACHINES

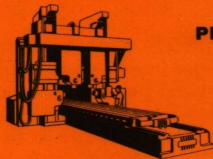

PLANER-TYPE MILLS

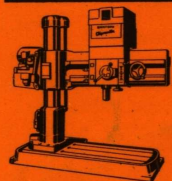

RADIAL DRILLING MACHINES



NUMERIDRILLS

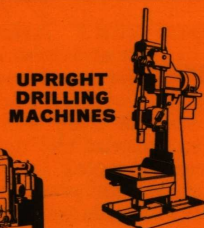

UPRIGHT DRILLING MACHINES

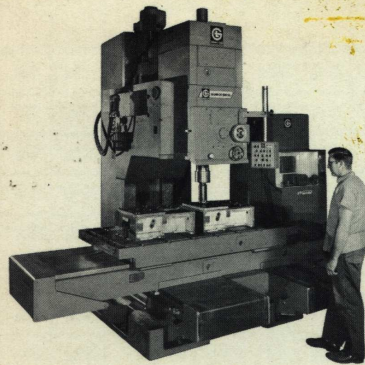

NUMERIDRILL* — The Numeripoint* tape-controlled table is accurate to $\pm .001$ " on hole centers with repeatability of $\pm .0005$ ". Traverse is 200"/min. Sizes range from 38 x 50" to 38 x 66". Capacity to 5 tons. Manual- and Numeripoint-controlled automatic drilling machines are available for use in conjunction with the Numeripoint table, providing manual 2-axis machines, 2-axis machines with spindle cycling, or fully automatic 3-axis units, which include speed and feed control.

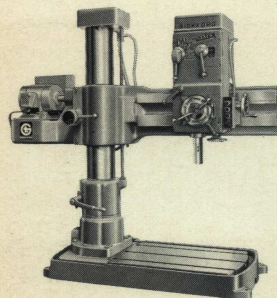

RADIALS—Bickford Chipmaster radial drilling machines are built in 9, 11, 13, 15, 17, 19, 22, 26, and 34-inch column sizes with drive motors from 3 to 50 hp. The 13"-19" and 34" machines are available with preselection of speeds, or of speeds and feeds.

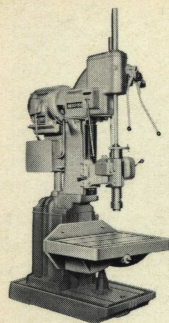
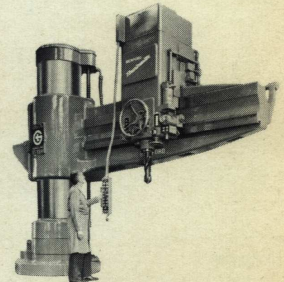

UPRIGHTS—The complete line, from 21" through 39" sizes, includes general-purpose, production and autocycle types of line, precision production drills, gang drills and the tape-controlled NumeriMite* for drilling, tapping and boring. Drive motors range from 3 to 10 hp.

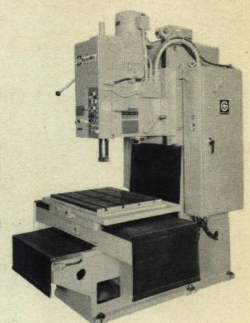

UNIVERSALS—Universal radial drilling machines for radial, horizontal, angular, and compound-angular machining operations. Choice of 14" or 22" columns, 2½ or 4" diameter spindles, up to 20-hp spindle drive motors. Completely portable.

*Giddings & Lewis Trademarks

GIDDINGS & LEWIS MACHINE TOOL COMPANY
FOND DU LAC, WISCONSIN • ESTABLISHED 1859